

FITTING INSTRUCTION

Clamp mark in acc. with		Cables joining
ISO	PN	
1	L	Left directional lights
2	+	Rear fog lights
3	31	Ground
4	R	Right directional lights
5	58R	Right side parking lights
6	54	Stoplights
7	58L	Left side parking lights

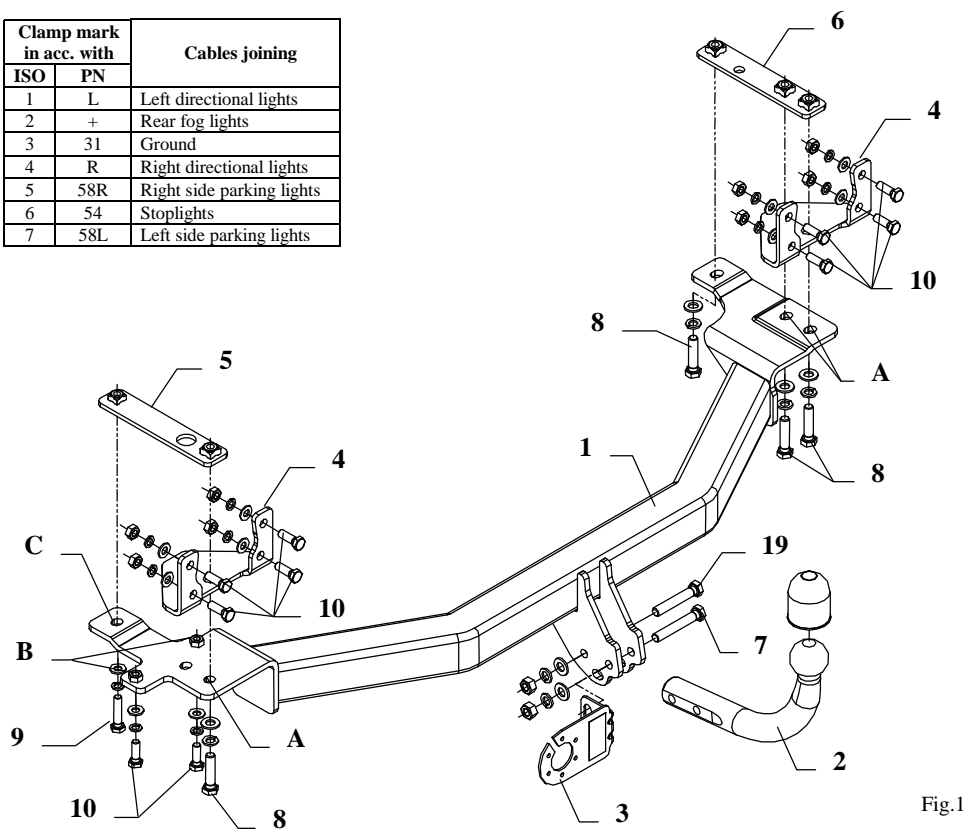

Fig.1

This towbar is designed to assembly in following cars: **VOLVO 850 ESTATE**, produced since 1993 till 1997, **VOLVO S70 4doors**, produced since 1997 till 2000 and **VOLVO V70 ESTATE**, produced since 1997 till 02.2000, catalogue no. **L03** and is prepared to tow trailers max total weight **1800 kg** and max vertical load **75 kg**.

From manufacturer

Thank you for buying our product. Their reliability has been confirmed in many tests. Reliability of towbar depends also on correct assembly and right operation. For this reasons we kindly ask to read carefully this instruction and apply to hints.

The towbar should be install in points described by a car producer.

The instruction of the assembly

1. Disassemble the bumper (unscrew four bolts and unrivet six rivets).
2. From the left and right side of the bumper unscrew metal elements - see fig. 2.
3. Unscrew rear muffler handle.
4. In types produced since 1993 disassemble element - see fig.3 (element not used any more). In types produced since 1997 unscrew elements - see fig.4, and next (before mount) straight theirs protruding parts.
5. Fix angle brackets (pos. 4) from the right and left side of suspension using bolts M10x30mm (pos. 10) - see fig.1.
6. To the chassis members slip elements (to left – pos. 5 and to right – pos. 6).
7. Put main bar of the towbar (pos. 1) from below the car and fix through towbar holes (pos. A) using bolts M12x50mm (pos. 8).

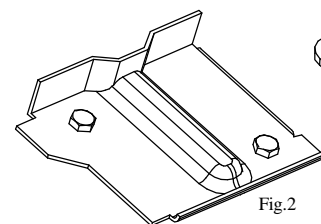

Fig.2

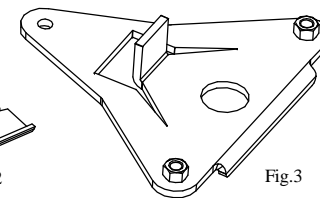

Fig.3

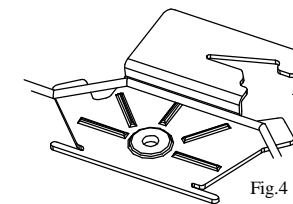

Fig.4

8. In types produced since 1993, early unscrewed muffler handle, screw in points (pos. B) using bolts M10x30mm (pos. 10). In types produced since 1997, handle fix in point (pos. C).
9. Reassemble the bumper (rivet to).
10. Fix tow ball (pos. 2) using bolt M12x75mm (pos. 7) and M12x70mm (pos. 19). With bolt M12x75mm fix also a socket plate (pos. 3). See figure 1.
11. Tighten all bolts according to the torque shown in the table.
12. Connect electric wires of 7-poles socket according to the instruction of the car. (Recommend to make at authorized service station)
13. Supplement the paint coating damaged during assembly.

Torque settings for nuts and bolts (8,8):

M 8 - 25 Nm	M 10 - 55 Nm
M 12 - 85 Nm	M 14 - 135 Nm





NOTE

After install the towbar you should get adequate note in registration book (at authorised service station).The car should be equipped with:

- Indicators
- Tow mirrors

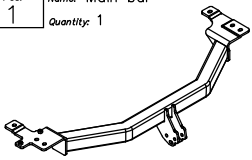
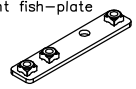
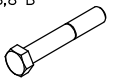
After 1000km check all bolts and nuts. The ball of towbar must be always kept clear and conserve with a grease.

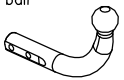
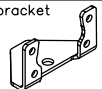
Towbar accessories:

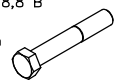
Pos. 1 Name: Main bar Quantity: 1	Pos. 5 Name: Left fish-plate Quantity: 1	Pos. 10 Name: Bolt 8,8 B Quantity: 10 Dim.: M10x30mm	Pos. 15 Name: Spring washer Quantity: 6 Dim.: \varnothing 12,2 mm
	Pos. 6 Name: Right fish-plate Quantity: 1	Pos. 11 Name: Nut 8 B Quantity: 2 Dim.: M12	Pos. 16 Name: Spring washer Quantity: 11 Dim.: \varnothing 10,2 mm
	Pos. 7 Name: Bolt 8,8 B Quantity: 1 Dim.: M12x75mm	Pos. 12 Name: Nut 8 B Quantity: 8 Dim.: M10	Pos. 17 Name: Rivet Quantity: 6 Dim.: \varnothing 5x20mm
	Pos. 8 Name: Socket plate Quantity: 1	Pos. 13 Name: Plain washer Quantity: 6 Dim.: \varnothing 13 mm	Pos. 18 Name: Ball cover Quantity: 1
	Pos. 9 Name: Bolt 8,8 B Quantity: 4 Dim.: M10x45mm	Pos. 14 Name: Plain washer Quantity: 11 Dim.: \varnothing 10,5 mm	
Pos. 2 Name: Tow ball Quantity: 1	Pos. 3 Name: Angle bracket Quantity: 2	Pos. 4 Name: Bolt 8,8 B Quantity: 1 Dim.: M10x70mm	Pos. 19 Name: Bolt 8,8 B Quantity: 1 Dim.: M12x70mm
			



PPUH AUTO-HAK S.J.

Produkcja Haków Holowniczych
Henryk & Zbigniew Nejman
76-200 SŁUPSK ul. Słoneczna 16K
tel/fax (059) 8-414-414; 8-414-413
E-mail: office@autohak.com.pl
www.autohak.com.pl

Towing hitch (without electrical set)

Class: **A50-X** Cat. no. **L03**

Designed for:

Manufacturer: **VOLVO**

Model: **850**

Type: **ESTATE**

produced since 1993 till 1997

Model: **S70**

Type: **4doors**

produced since 1997 till 2000

Model: **V70**

Type: **ESTATE**

produced since 1997 till 02.2000

Technical data:

D-value: 9,33 kN

maximum trailer weight: **1800 kg**

maximum vertical cup load: **75 kg**

Approval number acc. to regulations EKG/ONZ 55.01: **E20-55R-01 1111**

Foreword

This towbar is designed according to rules of safety traffic regulations. The towing hitch is a safety component and can be install only by qualified personnel. Any alteration or conversion of the towing hitch is prohibited and would lead to cancellation of design certification. Remove insulating compound and underseal from vehicle (if present) in the area of the matting surfaces of the towing hitch.

The vehicle manufacturer's specifications regarding trailer load and max. vertical cup load are decisive for driving whereat values for the towing hitch cannot be exceeded.

D-value formula:

$$\frac{\text{Max trailer weight [kg]} \times \text{Max vehicle weight [kg]}}{\text{Max trailer weight [kg]} + \text{Max vehicle weight [kg]}} \times \frac{9,81}{1000} = D \text{ [kN]}$$